



Model 350AST Double Check Valve Assembly

Application

Designed for installation on potable water lines to protect against both backsiphonage and backpressure of polluted water into the potable water supply. The Model 350AST shall provide protection where a potential health hazard does not exist. Ideal for use where Lead-Free* valves are required.

Standard Compliance (Horizontal and Vertical)

- ASSE® Listed 1015
 - AWWA Compliant C510 (with gates only), and C550
 - UL® Classified
 - C-UL® Classified
 - FM® Approved
 - CSA® Certified B64.5
 - cUPC® Listed
 - Approved by the Foundation for Cross Connection Control and Hydraulic Research at the University of Southern California
 - Meets the requirements of NSF/ANSI/CAN 61 and 372*
- *(LESS THAN 0.25% WEIGHTED AVERAGE LEAD CONTENT)

Materials

Main valve body	304L Stainless steel
Access covers	304L Stainless steel
Internals	Stainless steel, 300 Series NORYL™
Fasteners and springs	Stainless Steel, 300 Series
Seal ring	EPDM (FDA approved)
O-ring	Buna Nitrile (FDA approved)

Features

Sizes:	2 1/2", 3", 4", 6", 8", 10"
Maximum working water pressure	175 PSI
Maximum working water temperature	140°F
Hydrostatic test pressure	350 PSI
End connections	(Grooved for steel pipe) AWWA C606 (Flanged) ANSI B16.42 Class 150

Dimensions & Weights (do not include pkg.)

MODEL 350AST SIZE	WEIGHT														
	WITHOUT GATES		WITH NRS GATES (GXF)		WITH OS&Y GATES (GXF)		WITH NRS GATES (GXG)		WITH OS&Y GATES (GXG)		WITH BUTTERFLY VALVES (GXG)		WITH BUTTERFLY VALVES (GXF)		
	in.	mm	lbs.	kg	lbs.	kg	lbs.	kg	lbs.	kg	lbs.	kg	lbs.	kg	
2 1/2	65	33	15	94	43	112	51	86	39	104	47	79	36	89	40
3	80	34	15.4	112	51	130	60	102	46	120	54	83	38	96	44
4	100	35	15.8	168	76	204	93	142	64	184	83	87	39	109	50
6	150	63	29	280	127	338	153	250	114	308	140	150	68	180	82
8	200	177	80	565	256	647	293	525	238	593	269	347	112	393	178
10	250	177	80	769	349	865	392	717	325	807	366	443	200	501	227

MODEL 350AST SIZE	DIMENSION (approximate)																						
	A		A WITH BUTTERFLY		B LESS GATE VALVES		C		D		E NRS GATE		E OS&Y OPEN		E OS&Y CLOSED		E WITH BUTTERFLY VALVES		F		G		
	in.	mm	in.	mm	in.	mm	in.	mm	in.	mm	in.	mm	in.	mm	in.	mm	in.	mm	in.	mm	in.	mm	
2 1/2	65	31 7/8	810	28 3/4	730	16 5/8	422	4 1/2	114	7 1/4	184	11 1/2	292	17 3/4	451	15 3/8	391	8 1/4	210	5	127	42	1067
3	80	32 7/8	835	29 3/8	746	16 5/8	422	4 1/2	114	7 1/4	184	12 3/4	324	20 1/4	514	17	432	8 1/4	210	5	127	43 1/2	1105
4	100	34 7/8	886	30 1/4	768	16 5/8	422	4 1/2	114	8	203	14 1/2	368	22 1/2	572	18 1/4	464	9	229	5	127	50	1270
6	150	43 1/2	1105	36 1/2	927	22 1/4	565	5 1/2	140	10	254	18	457	30 1/2	775	24 1/4	616	10 1/4	260	6	152	61 5/8	1565
8	200	52 3/4	1340	45 3/4	1162	29 1/2	749	9 1/4	235	11	279	21 1/8	537	37	940	28 1/2	724	18 1/2	470	8 3/8	213	77 1/8	1959
10	250	55 3/4	1416	49 3/4	1264	29 1/2	749	9 1/4	235	12	305	24 3/4	629	45 5/8	1159	34 3/4	883	18 1/2	470	8 3/8	213	85 3/8	2169

Zurn Water, LLC | Wilkins
1747 Commerce Way, Paso Robles, CA U.S.A. 93446 Ph. 855-663-9876, Fax 805-238-5766
In Canada | Zurn Industries Limited
7900 Goreway Drive, Unit 10, Brampton, Ontario L6T 5W6, 877-892-5216
www.zurn.com

Rev. R
Date: 8/24
Document No. BF-350AST
Product No. Model 350AST
Patent zurn.com/patents



NSF/ANSI/CAN 61 & 372

(SHOWN WITH OPTIONAL OSY GATE VALVES)

Options

(Suffixes can be combined)

- with flanged end NRS gate valves (standard)
- FSC - with epoxy coated wye type strainer (flanged only)
- G - with grooved end NRS gate valves
- GF - with grooved inlet gate connection and flanged outlet gate connection
- FG - with flanged inlet gate connection and grooved outlet gate connection
- OSY - flanged end OS&Y gate valves
- OSYG - with grooved end OS&Y gate valves
- PI - with Post Indicator Gate Valves
- BG - with grooved end butterfly valves with integral supervisory switches
- BF - with flanged end butterfly valves with integral supervisory switches

*New Connected Products. Search [ZCSM-PF on Zurn.com](http://ZCSM-PF.on.Zurn.com) for details.

Accessories

- Connected Pressure Monitor (Model ZCSM-PF)*
- Repair kit (rubber only)
- Thermal expansion tank (Model XT)
- OS & Y Gate valve tamper switch (OSY-40)

MODEL 350AST
with OSY &
FSC option

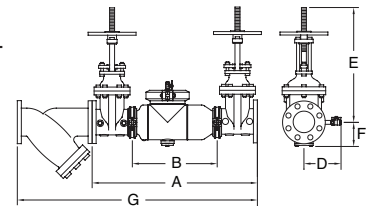

MODEL 350AST
with BG option

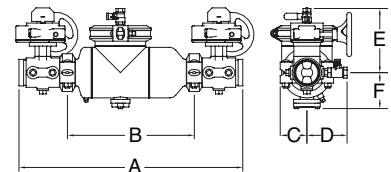

MODEL 350AST 2 1/2", 3" & 4" (STANDARD & METRIC)

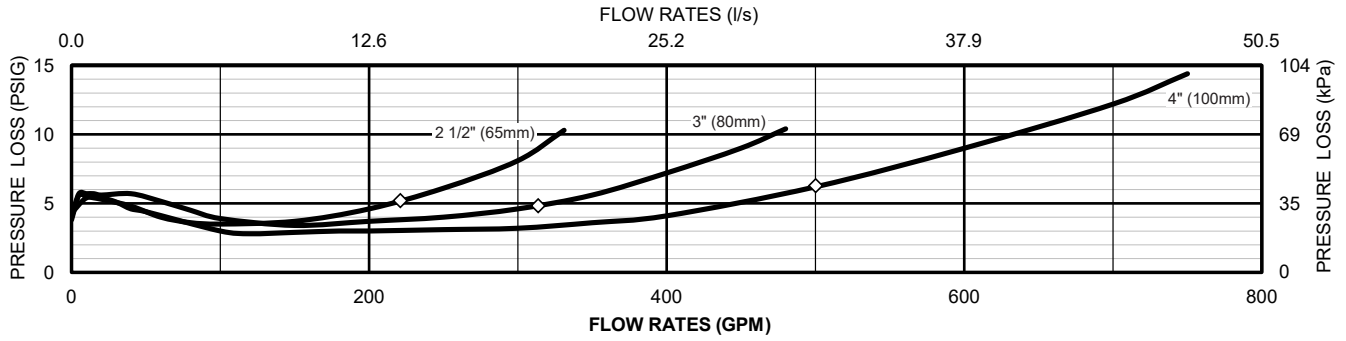

MODEL 350AST 6", 8" & 10" (STANDARD & METRIC)

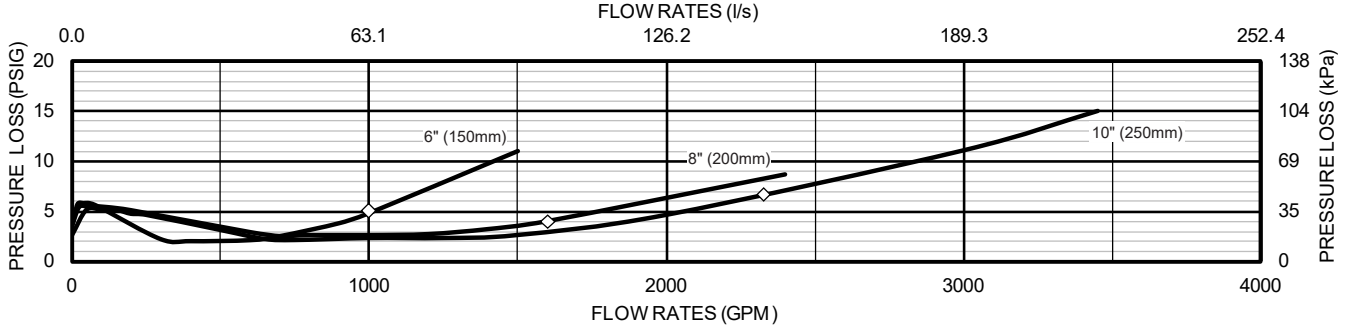

Typical Installation

Local codes shall govern installation requirements. Unless otherwise specified, the assembly shall be mounted at a minimum of 12" (305mm) and a maximum of 30" (762mm) above adequate drains with sufficient side clearance for testing and maintenance. The installation shall be made so that no part of the unit can be submerged.

Capacity thru Schedule 40 Pipe (GPM)				
Pipe size	5 ft/sec	7.5 ft/sec	10 ft/sec	15 ft/sec
2 1/2"	75	112	149	224
3"	115	173	230	346
4"	198	298	397	595
6"	450	675	900	1351
8"	780	1169	1559	2339
10"	1229	1843	2458	3687
12"	1763	2644	3525	5288

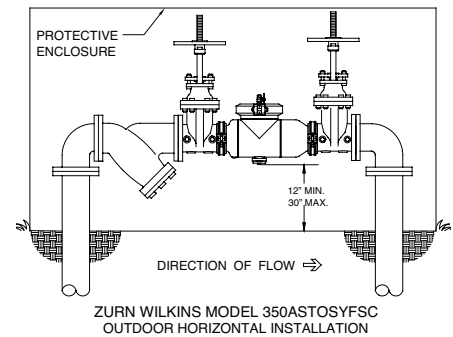
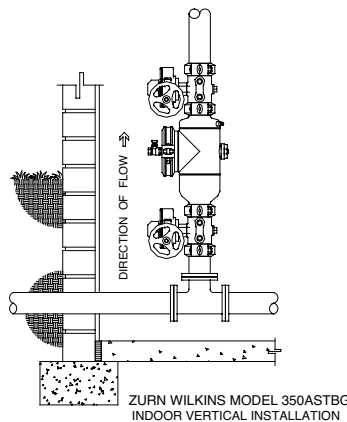
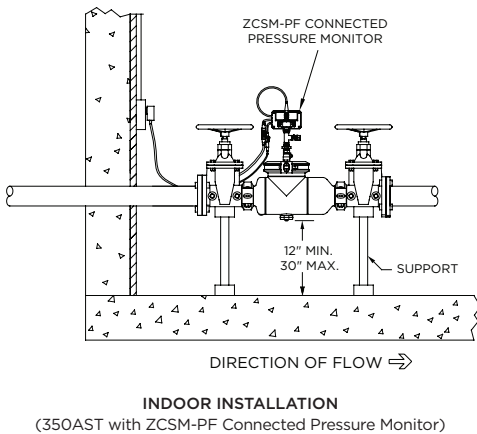

Specifications

The Double Check Backflow Prevention Assembly shall be certified to NSF/ANSI/CAN 61 and 372, ASSE® Listed 1015, and supplied with full port gate valves. The main body and access cover shall be 304L Stainless Steel, the seat ring and check valve shall be NORYL™, the stem shall be stainless steel (ASTM A 276) and the seat disc elastomers shall be EPDM. The checks shall be accessible for maintenance without removing the device from the line. The Double Check Backflow Prevention Assembly shall be a ZURN WILKINS Model 350AST.